

IRS2184/IRS21844(S)PbF HALF-BRIDGE DRIVER

Features

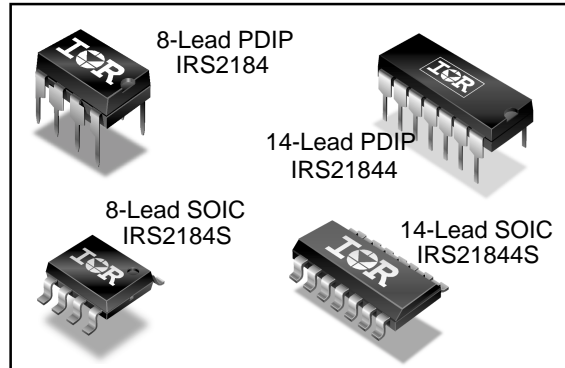
- Floating channel designed for bootstrap operation
- Fully operational to +600 V
- Tolerant to negative transient voltage, dV/dt immune
- Gate drive supply range from 10 V to 20 V
- Undervoltage lockout for both channels
- 3.3 V and 5 V input logic compatible
- Matched propagation delay for both channels
- Logic and power ground +/- 5 V offset
- Lower di/dt gate driver for better noise immunity
- Output source/sink current capability 1.4 A/1.8 A
- RoHS compliant

Description

The IRS2184/IRS21844 are high voltage, high speed power MOSFET and IGBT drivers with dependent high-side and low-side referenced output channels. Proprietary HVIC and latch immune CMOS technologies enable ruggedized monolithic construction. The logic input is compatible with standard CMOS or LSTTL output, down to 3.3 V logic. The output drivers feature a

high pulse current buffer stage designed for minimum driver cross-conduction. The floating channel can be used to drive an N-channel power MOSFET or IGBT in the high-side configuration which operates up to 600 V.

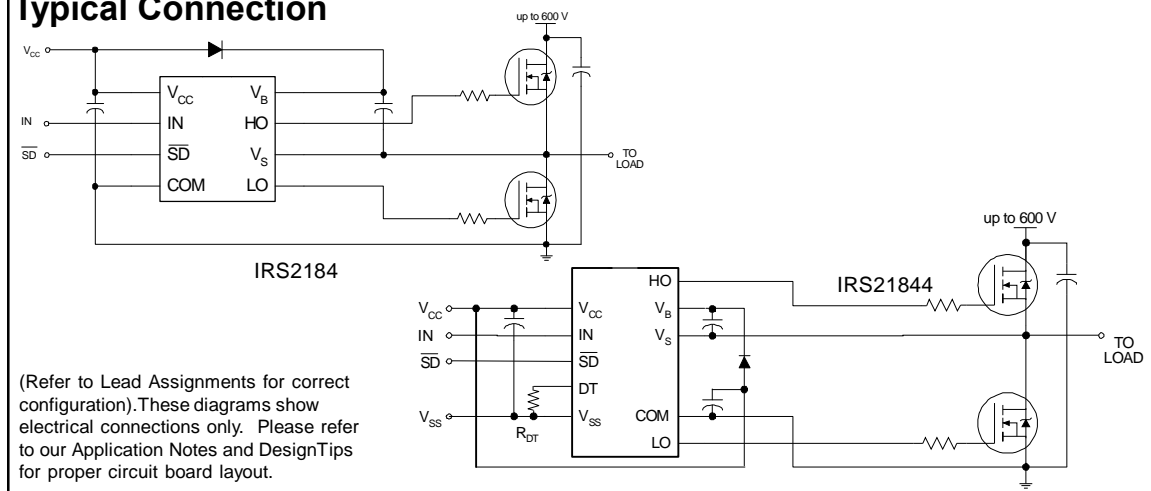
Packages



Feature Comparison

Part	Input logic	Cross-conduction prevention logic	Deadtime (ns)	Ground Pins	ton/toff (ns)
2181	HIN/LIN	no	none	COM	180/220
21814				Vss/COM	
2183	HIN/LIN	yes	Internal 400 Program 400-5000	COM	180/220
21834				Vss/COM	
2184	IN/SD	yes	Internal 400 Program 400-5000	COM	680/270
21844				Vss/COM	

Typical Connection



Absolute Maximum Ratings

Absolute maximum ratings indicate sustained limits beyond which damage to the device may occur. All voltage parameters are absolute voltages referenced to COM. The thermal resistance and power dissipation ratings are measured under board mounted and still air conditions.

Symbol	Definition	Min.	Max.	Units	
V _B	High-side floating absolute voltage	-0.3	620 (Note 1)	V	
V _S	High-side floating supply offset voltage	V _B - 20	V _B + 0.3		
V _{HO}	High-side floating output voltage	V _S - 0.3	V _B + 0.3		
V _{CC}	Low-side and logic fixed supply voltage	-0.3	20 (Note 1)		
V _{LO}	Low-side output voltage	-0.3	V _{CC} + 0.3		
DT	Programmable deadtime pin voltage (IRS21844 only)	V _{SS} - 0.3	V _{CC} + 0.3		
V _{IN}	Logic input voltage (IN & \overline{SD})	V _{SS} - 0.3	V _{CC} + 0.3		
V _{SS}	Logic ground (IRS21844 only)	V _{CC} - 20	V _{CC} + 0.3		
dV _S /dt	Allowable offset supply voltage transient	—	50	V/ns	
P _D	Package power dissipation @ T _A ≤ +25 °C	(8-lead PDIP)	—	1.0	W
		(8-lead SOIC)	—	0.625	
		(14-lead PDIP)	—	1.6	
		(14-lead SOIC)	—	1.0	
R _{thJA}	Thermal resistance, junction to ambient	(8-lead PDIP)	—	125	°C/W
		(8-lead SOIC)	—	200	
		(14-lead PDIP)	—	75	
		(14-lead SOIC)	—	120	
T _J	Junction temperature	—	150	°C	
T _S	Storage temperature	-50	150		
T _L	Lead temperature (soldering, 10 seconds)	—	300		

Note 1: All supplies are fully tested at 25 V and an internal 20 V clamp exists for each supply.

Recommended Operating Conditions

The input/output logic timing diagram is shown in Fig. 1. For proper operation the device should be used within the recommended conditions. The V_S and V_{SS} offset rating are tested with all supplies biased at a 15 V differential.

Symbol	Definition	Min.	Max.	Units
V _B	High-side floating supply absolute voltage	V _S + 10	V _S + 20	V
V _S	High-side floating supply offset voltage	Note 2	600	
V _{HO}	High-side floating output voltage	V _S	V _B	
V _{CC}	Low-side and logic fixed supply voltage	10	20	
V _{LO}	Low-side output voltage	0	V _{CC}	
V _{IN}	Logic input voltage (IN & \overline{SD})	V _{SS}	V _{CC}	
DT	Programmable deadtime pin voltage (IRS21844 only)	V _{SS}	V _{CC}	
V _{SS}	Logic ground (IRS21844 only)	-5	5	
T _A	Ambient temperature	-40	125	°C

Note 2: Logic operational for V_S of -5 V to +600 V. Logic state held for V_S of -5 V to -V_{BS}. (Please refer to the Design Tip DT97-3 for more details).

Dynamic Electrical Characteristics

$V_{BIAS} (V_{CC}, V_{BS}) = 15\text{ V}$, $V_{SS} = \text{COM}$, $C_L = 1000\text{ pF}$, $T_A = 25^\circ\text{ C}$, $DT = V_{SS}$ unless otherwise specified.

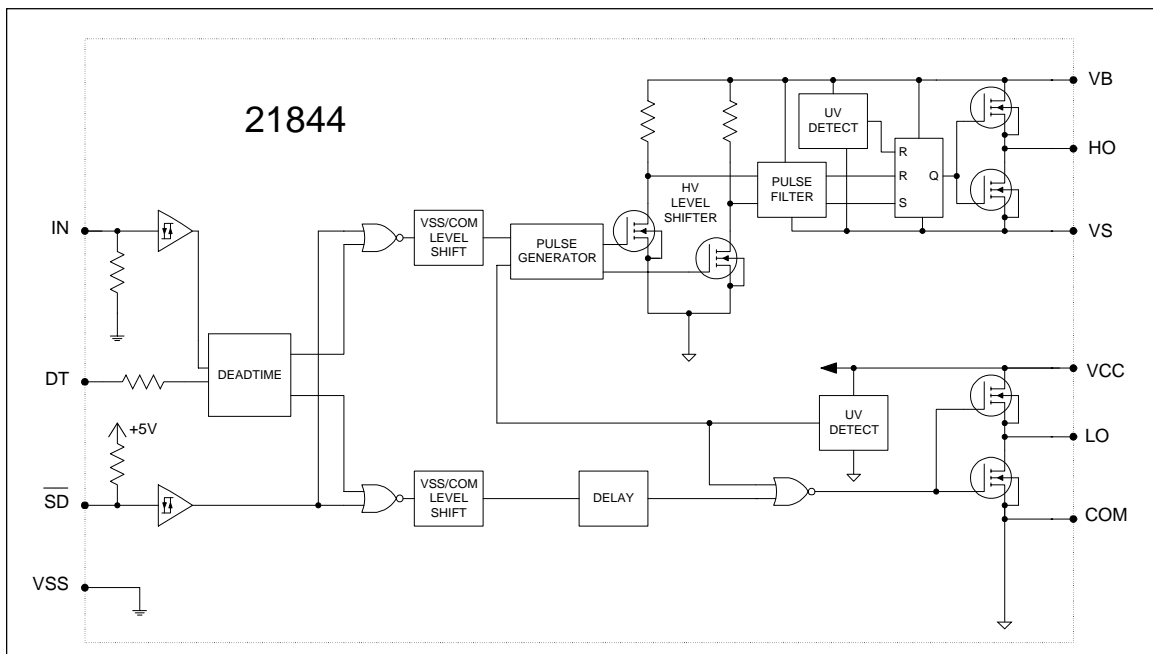
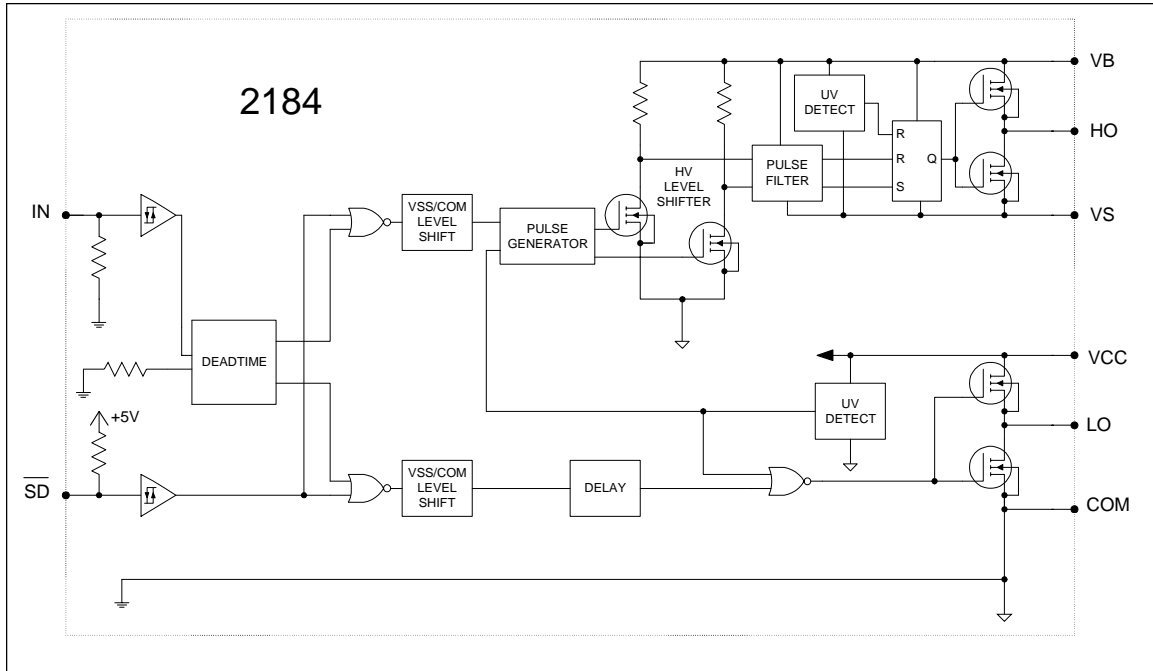
Symbol	Definition	Min.	Typ.	Max.	Units	Test Conditions
t_{on}	Turn-on propagation delay	—	680	900	ns	$V_S = 0\text{ V}$
t_{off}	Turn-off propagation delay	—	270	400		$V_S = 0\text{ V}$ or 600 V
t_{sd}	Shut-down propagation delay	—	180	270		
MTon	Delay matching, HS & LS turn-on	—	0	90		
MToff	Delay matching, HS & LS turn-off	—	0	40		
t_r	Turn-on rise time	—	40	60		$V_S = 0\text{ V}$
t_f	Turn-off fall time	—	20	35		
DT	Deadtime: LO turn-off to HO turn-on (DT _{LO-HO}) & HO turn-off to LO turn-on (DT _{HO-LO})	280	400	520	μs	$R_{DT} = 0\ \Omega$
		4	5	6		$R_{DT} = 200\text{ k}\Omega$
MDT	Deadtime matching = $DT_{LO} - HO - DT_{HO-LO}$	—	0	50	ns	$R_{DT} = 0\ \Omega$
		—	0	600		$R_{DT} = 200\text{ k}\Omega$

Static Electrical Characteristics

$V_{BIAS} (V_{CC}, V_{BS}) = 15\text{ V}$, $V_{SS} = \text{COM}$, $DT = V_{SS}$ and $T_A = 25^\circ\text{ C}$ unless otherwise specified. The V_{IL} , V_{IH} , and I_{IN} parameters are referenced to V_{SS}/COM and are applicable to the respective input leads: IN and SD. The V_O , I_O , and R_{on} parameters are referenced to COM and are applicable to the respective output leads: HO and LO.

Symbol	Definition	Min.	Typ.	Max.	Units	Test Conditions
V_{IH}	Logic "1" input voltage for HO & logic "0" for LO	2.5	—	—	V	$V_{CC} = 10\text{ V}$ to 20 V
V_{IL}	Logic "0" input voltage for HO & logic "1" for LO	—	—	0.8		
$V_{SD,TH+}$	\overline{SD} input positive going threshold	2.5	—	—		
$V_{SD,TH-}$	\overline{SD} input negative going threshold	—	—	0.8		
V_{OH}	High level output voltage, $V_{BIAS} - V_O$	—	—	1.4		
V_{OL}	Low level output voltage, V_O	—	—	0.2	$I_O = 20\text{ mA}$	
I_{LK}	Offset supply leakage current	—	—	50	μA	$V_B = V_S = 600\text{ V}$
I_{QBS}	Quiescent V_{BS} supply current	20	60	150	mA	$V_{IN} = 0\text{ V}$ or 5 V
I_{QCC}	Quiescent V_{CC} supply current	0.4	1.0	1.6		
I_{IN+}	Logic "1" input bias current	—	25	60	μA	$IN = 5\text{ V}$, $\overline{SD} = 0\text{ V}$
I_{IN-}	Logic "0" input bias current	—	—	5.0		$IN = 0\text{ V}$, $\overline{SD} = 5\text{ V}$
V_{CCUV+} V_{BSUV+}	V_{CC} and V_{BS} supply undervoltage positive going threshold	8.0	8.9	9.8	V	
V_{CCUV-} V_{BSUV-}	V_{CC} and V_{BS} supply undervoltage negative going threshold	7.4	8.2	9.0		
V_{CCUVH} V_{BSUVH}	Hysteresis	0.3	0.7	—		
I_{O+}	Output high short circuit pulsed current	1.4	1.9	—	A	$V_O = 0\text{ V}$, $PW \leq 10\ \mu\text{s}$
I_{O-}	Output low short circuit pulsed current	1.8	2.3	—		$V_O = 15\text{ V}$, $PW \leq 10\ \mu\text{s}$

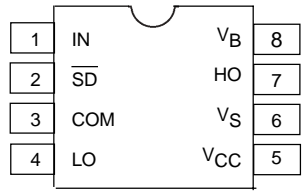
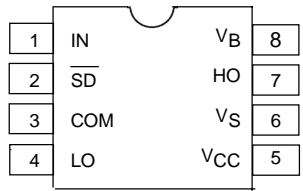
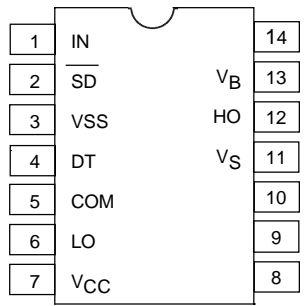
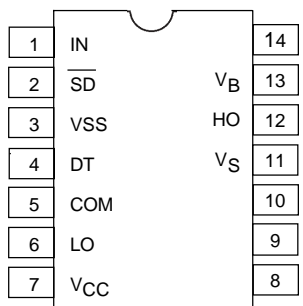
Functional Block Diagrams



Lead Definitions

Symbol	Description
IN	Logic input for high-side and low-side gate driver outputs (HO and LO), in phase with HO (referenced to COM for IRS2184 and VSS for IRS21844)
\overline{SD}	Logic input for shutdown (referenced to COM for IRS2184 and VSS for IRS21844)
DT	Programmable deadtime lead, referenced to VSS. (IRS21844 only)
VSS	Logic ground (IRS21844 only)
V_B	High-side floating supply
HO	High-side gate drive output
V_S	High-side floating supply return
V_{CC}	Low-side and logic fixed supply
LO	Low-side gate drive output
COM	Low-side return

Lead Assignments

 <p>8-Lead PDIP</p> <p>IRS2184PbF</p>	 <p>8-Lead SOIC</p> <p>IRS2184SPbF</p>
 <p>14-Lead PDIP</p> <p>IRS21844PbF</p>	 <p>14-Lead SOIC</p> <p>IRS21844SPbF</p>

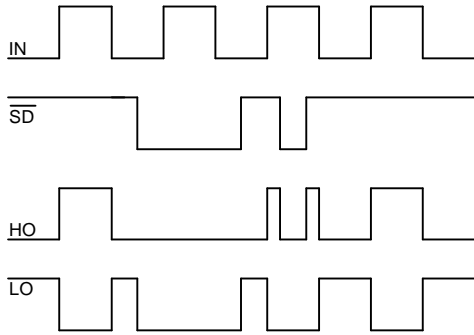


Figure 1. Input/Output Timing Diagram

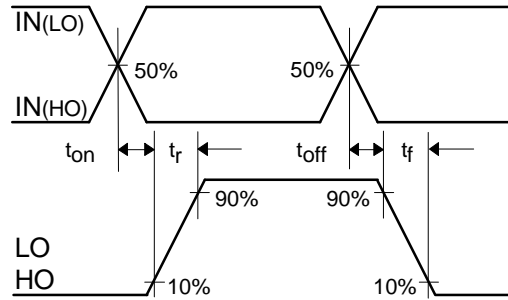


Figure 2. Switching Time Waveform Definitions

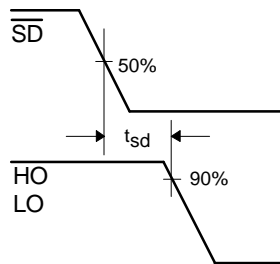


Figure 3. Shutdown Waveform Definitions

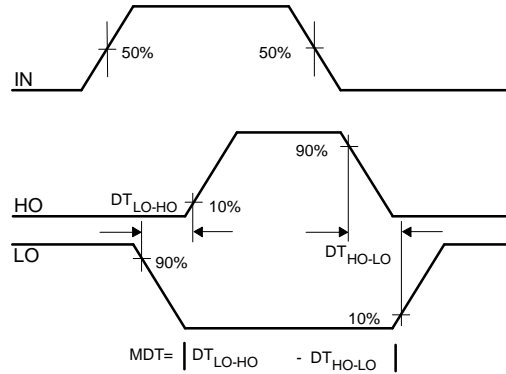


Figure 4. Deadtime Waveform Definitions

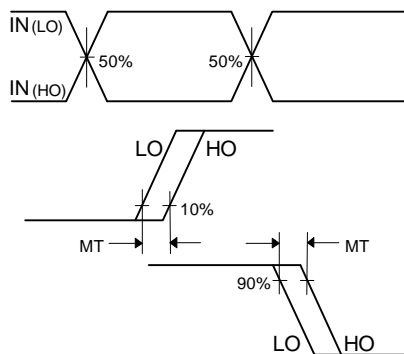


Figure 5. Delay Matching Waveform Definitions

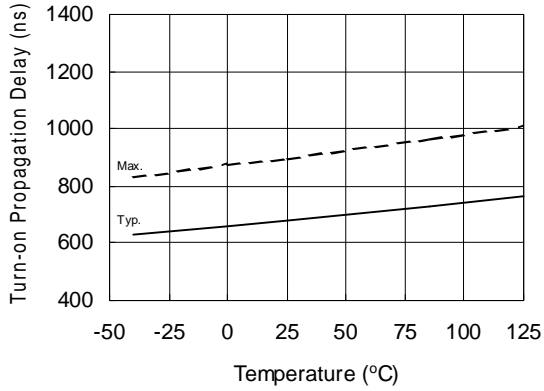


Figure 6A. Turn-On Propagation Delay vs. Temperature

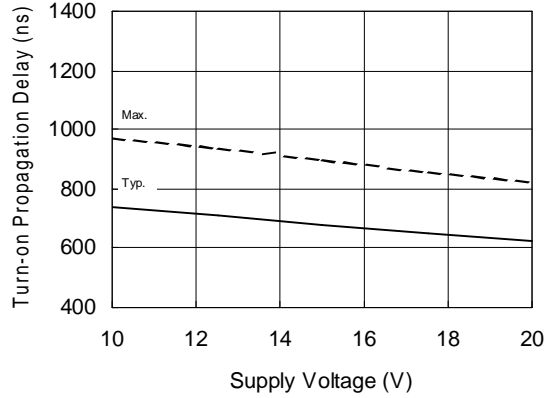


Figure 6B. Turn-On Propagation Delay vs. Supply Voltage

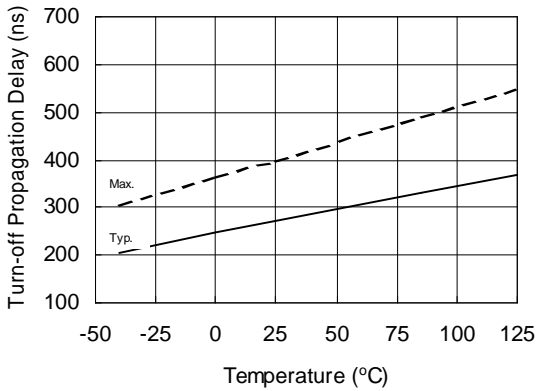


Figure 7A. Turn-Off Propagation Delay vs. Temperature

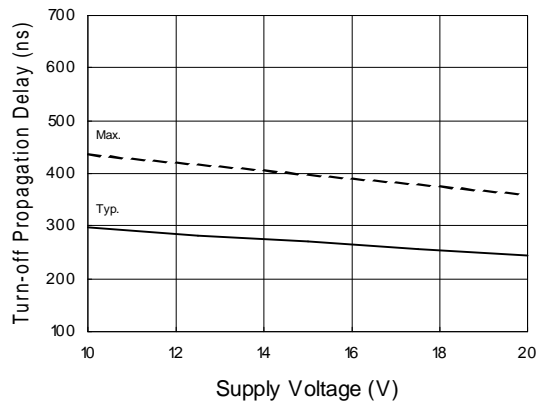


Figure 7B. Turn-Off Propagation Delay vs. Supply Voltage

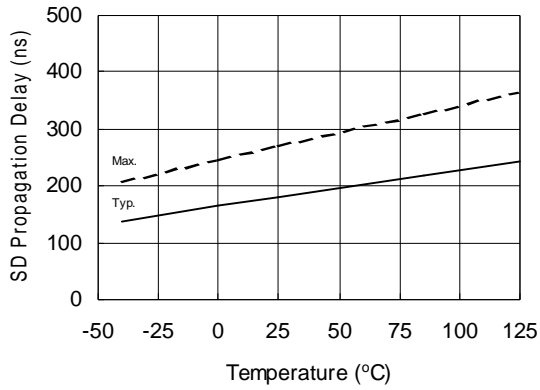


Figure 8A. SD Propagation Delay vs. Temperature

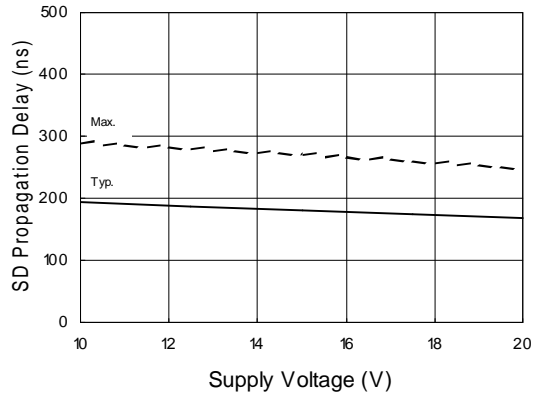


Figure 8B. SD Propagation Delay vs. Supply Voltage

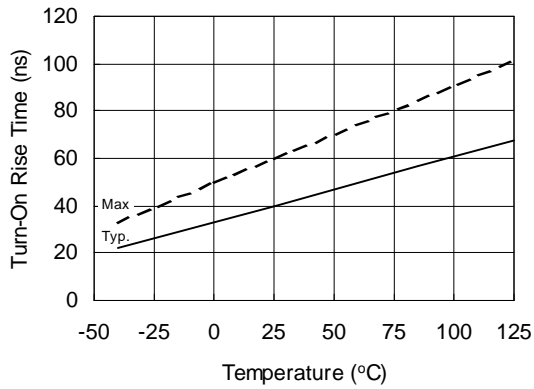


Figure 9A. Turn-On Rise Time vs. Temperature

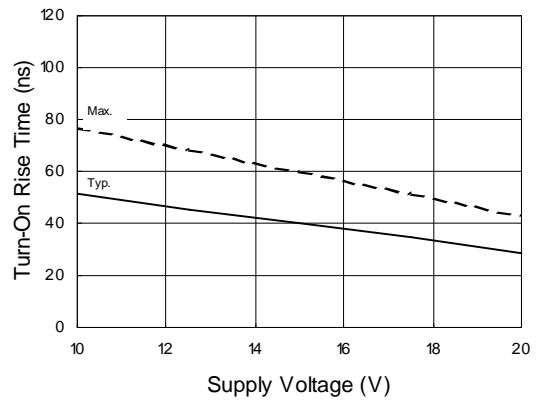


Figure 9B. Turn-On Rise Time vs. Supply Voltage

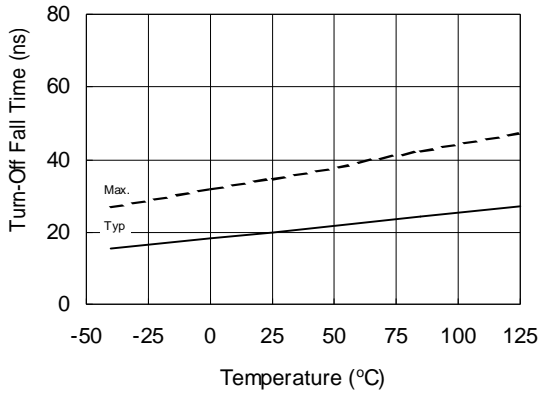


Figure 10A. Turn-Off Fall Time vs. Temperature

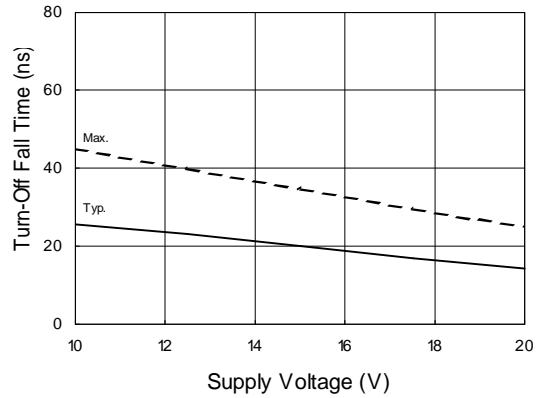


Figure 10B. Turn-Off Fall Time vs. Supply Voltage

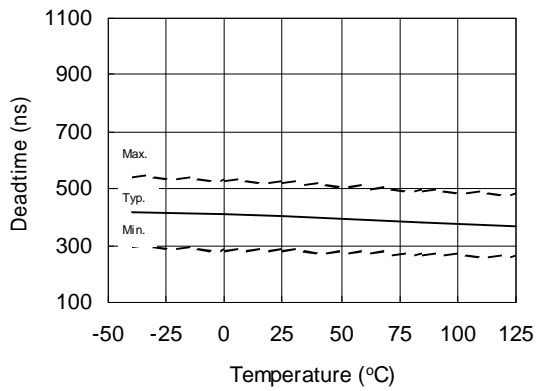


Figure 11A. Deadtime vs. Temperature

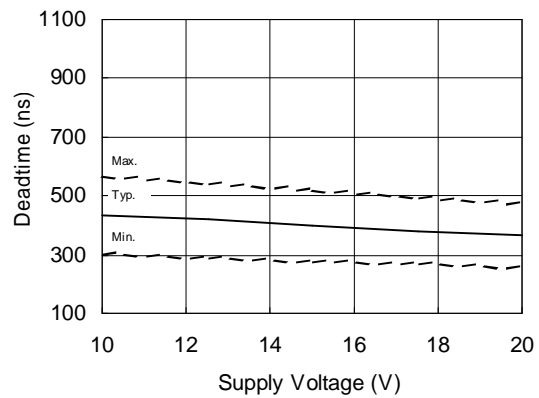


Figure 11B. Deadtime vs. Supply Voltage

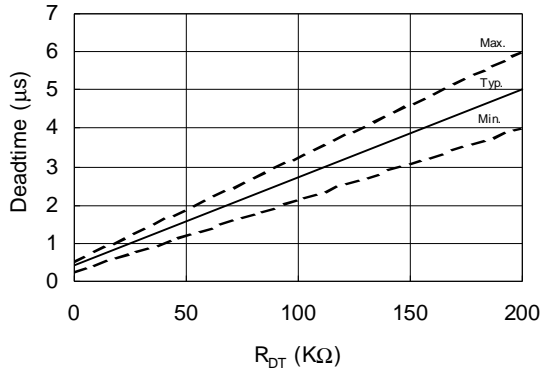


Figure 11C. Deadtime vs. R_{DT}

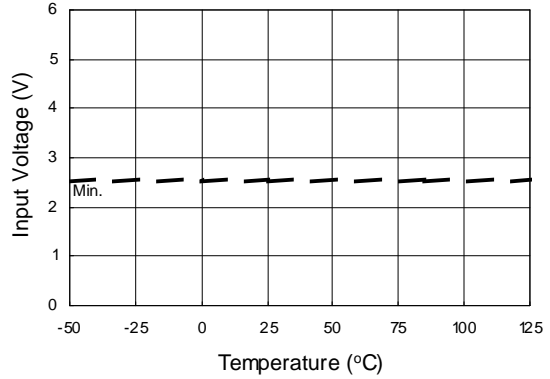


Figure 12A. Logic "1" Input Voltage vs. Temperature

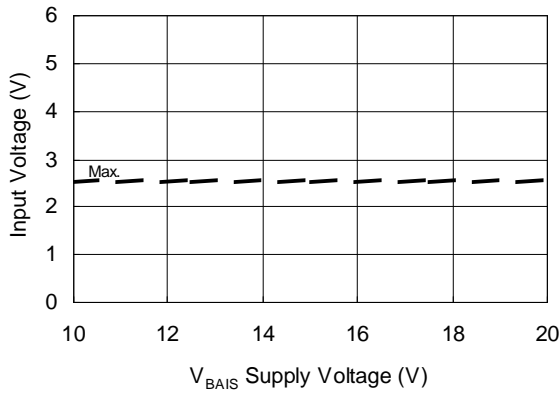


Figure 12B. Logic "1" Input Voltage vs. Supply Voltage

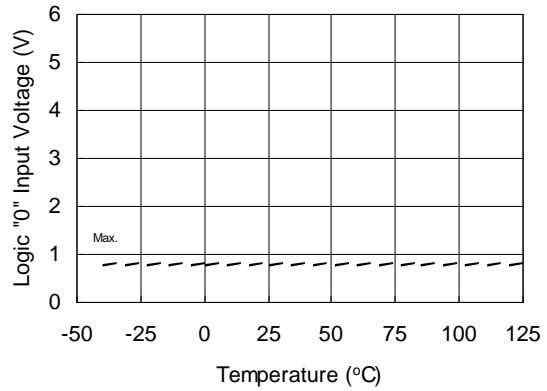


Figure 13A. Logic "0" Input Voltage vs. Temperature

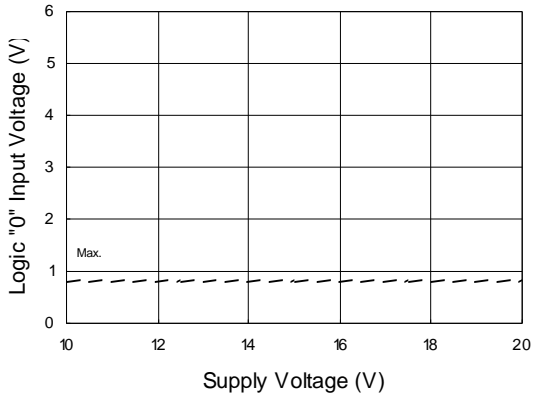


Figure 13B. Logic "0" Input Voltage vs. Supply Voltage

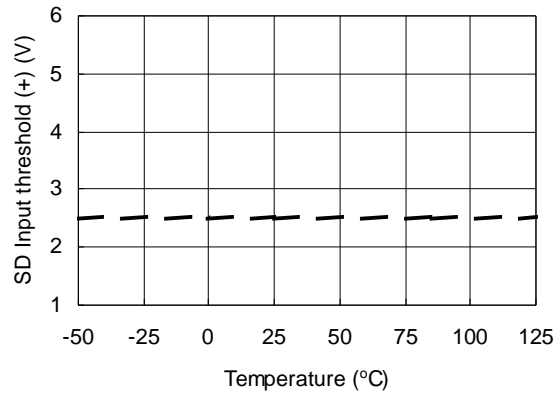


Figure 14A. SD input positive going threshold (+) vs. Temperature

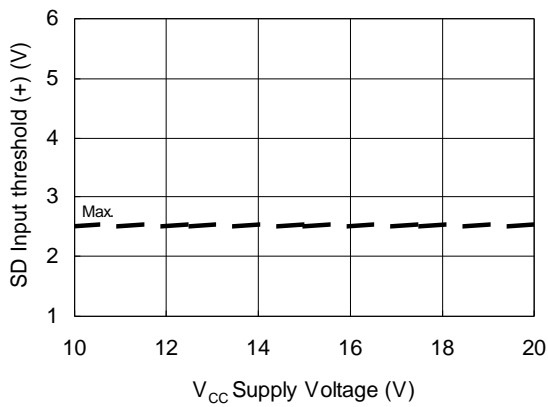


Figure 14B. SD input positive going threshold (+) vs. Supply Voltage

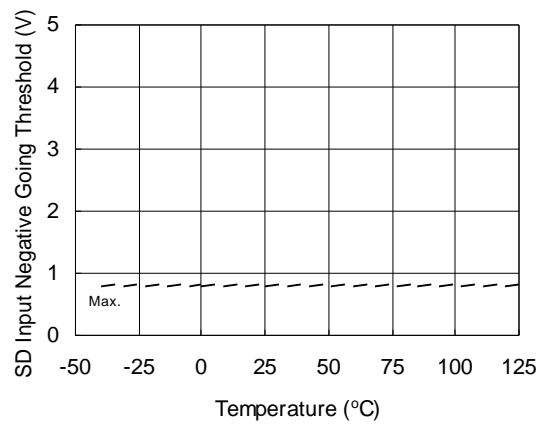


Figure 15A. SD Input Negative Going Threshold vs. Temperature

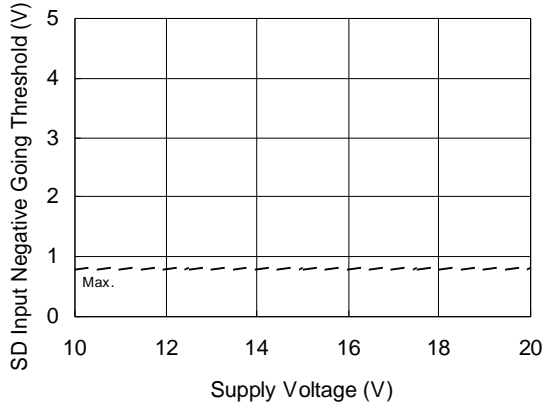


Figure 15B. SD Input Negative Going Threshold vs. Supply Voltage

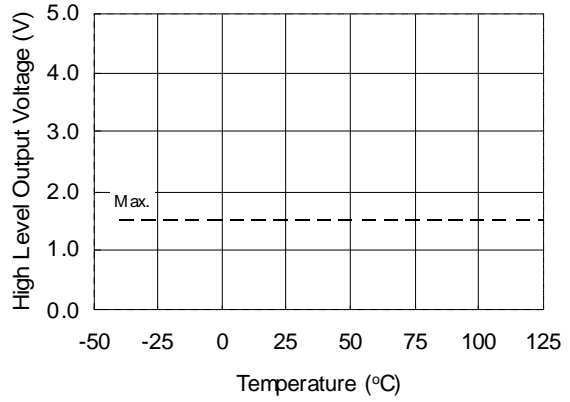


Figure 16A. High Level Output Voltage vs. Temperature ($I_o = 0$ mA)

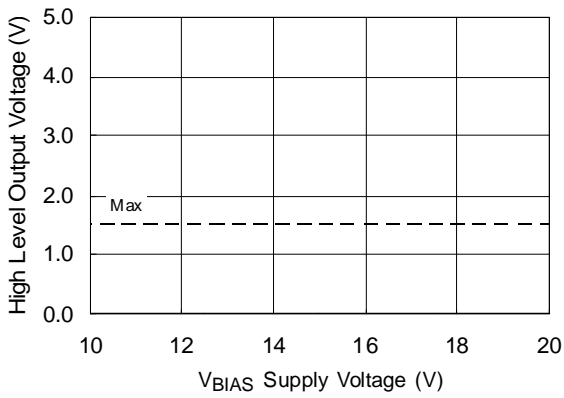


Figure 16B. High Level Output Voltage vs. Supply Voltage ($I_o = 0$ mA)

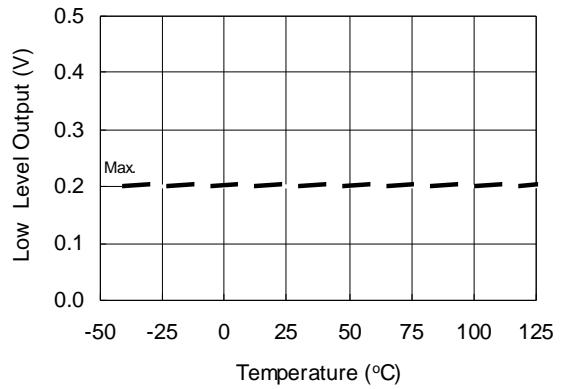


Figure 17A. Low Level Output vs. Temperature

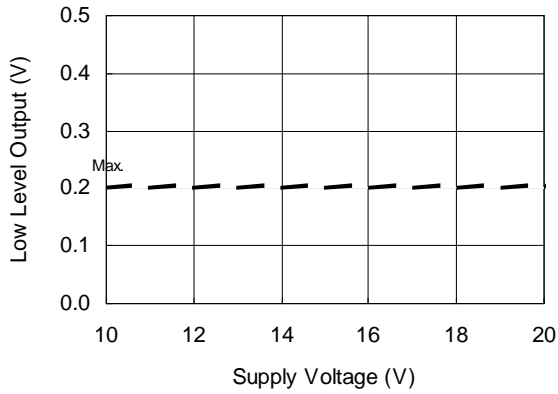


Figure 17B. Low Level Output vs. Supply Voltage

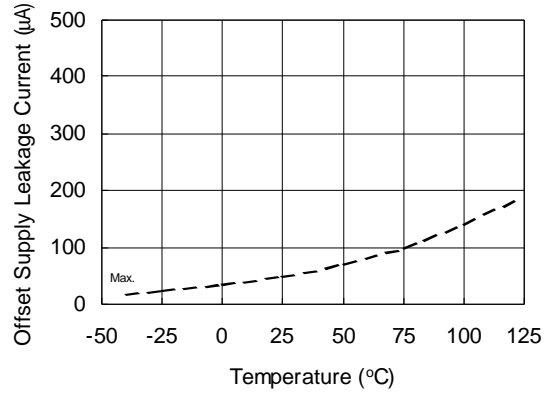


Figure 18A. Offset Supply Leakage Current vs. Temperature

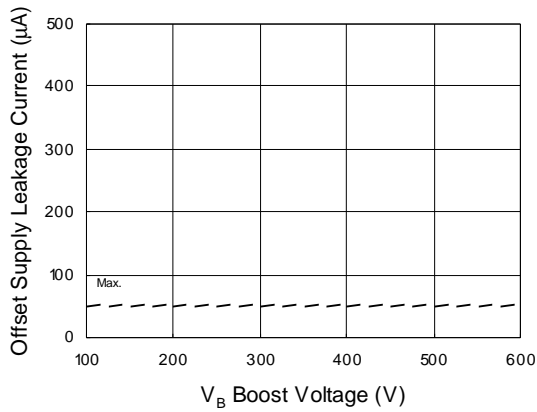


Figure 18B. Offset Supply Leakage Current vs. V_B Boost Voltage

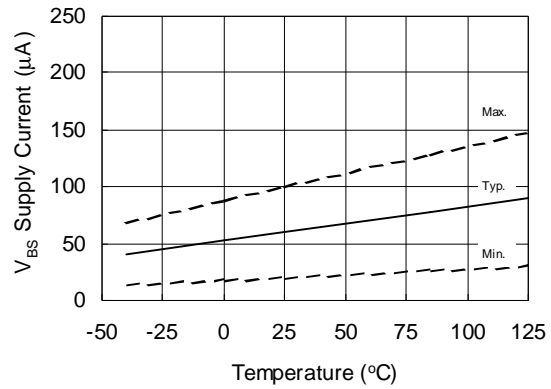


Figure 19A. V_{BS} Supply Current vs. Temperature

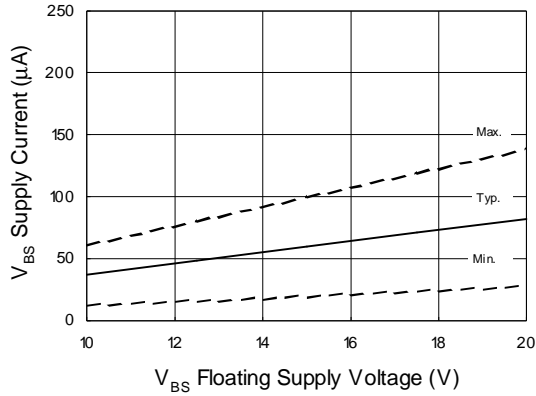


Figure 19B. V_{BS} Supply Current vs. V_{BS} Floating Supply Voltage

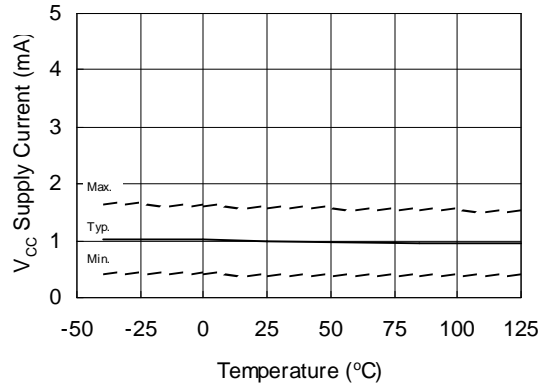


Figure 20A. V_{CC} Supply Current vs. Temperature

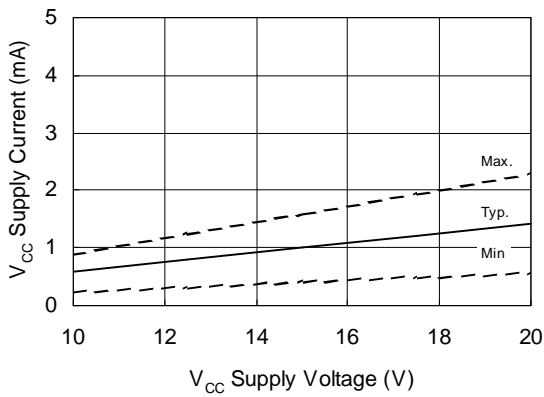


Figure 20B. V_{CC} Supply Current vs. V_{CC} Supply Voltage

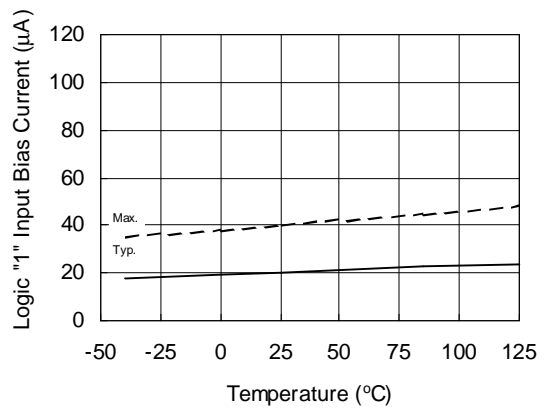


Figure 21A. Logic "1" Input Bias Current vs. Temperature

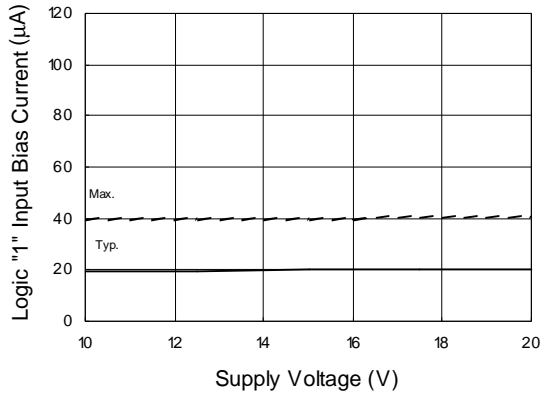


Figure 21B. Logic "1" Input Bias Current vs. Supply Voltage

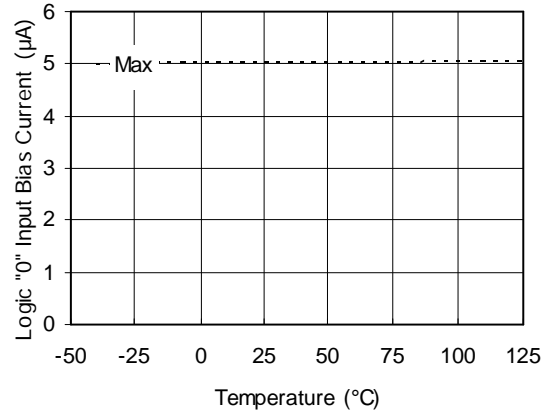


Figure 22A. Logic "0" Input Bias Current vs. Temperature

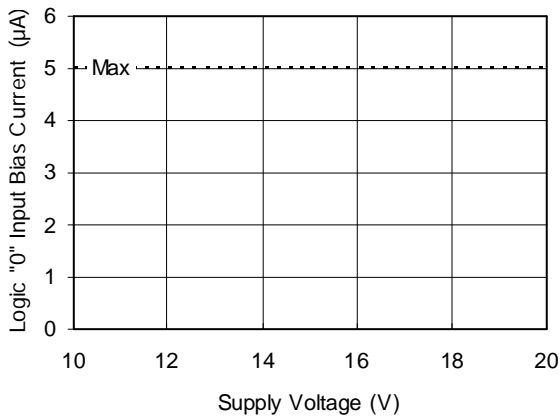


Figure 22B. Logic "0" Input Bias Current vs. Voltage

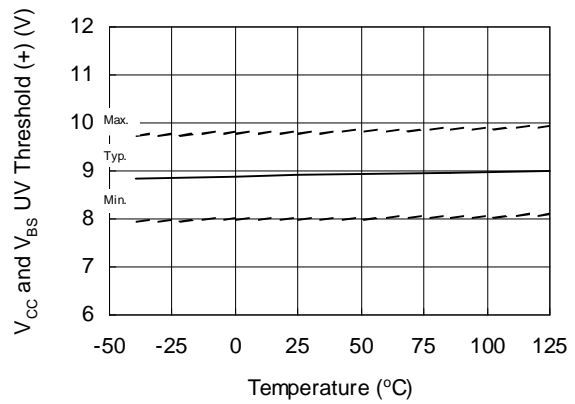


Figure 23. V_{CC} and V_{BS} Undervoltage Threshold (+) vs. Temperature

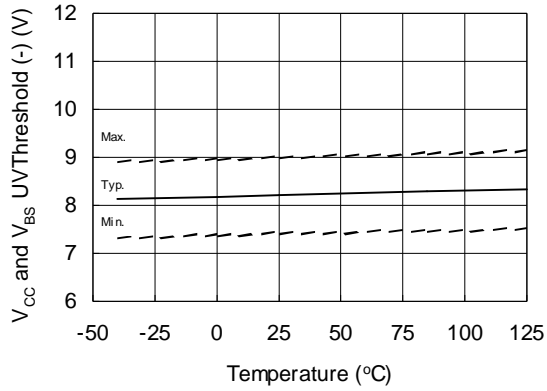


Figure 24. V_{CC} and V_{BS} Undervoltage Threshold (-) vs. Temperature

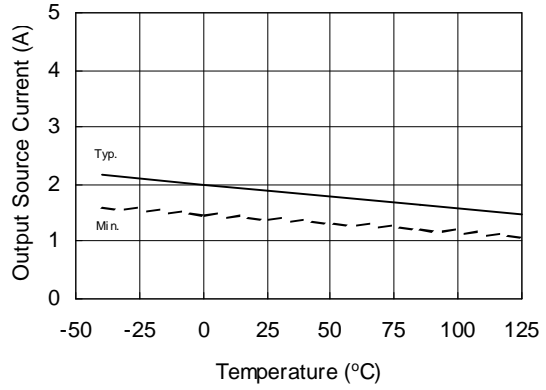


Figure 25A. Output Source Current vs. Temperature

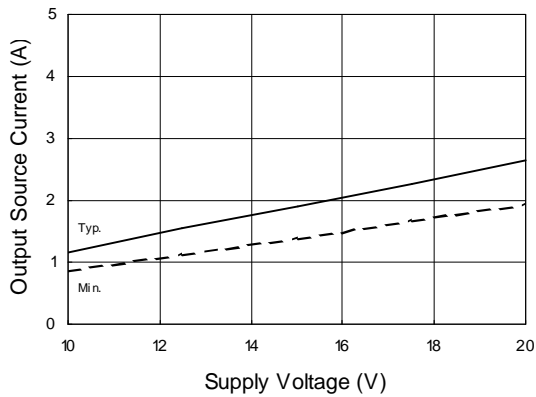


Figure 25B. Output Source Current vs. Supply Voltage

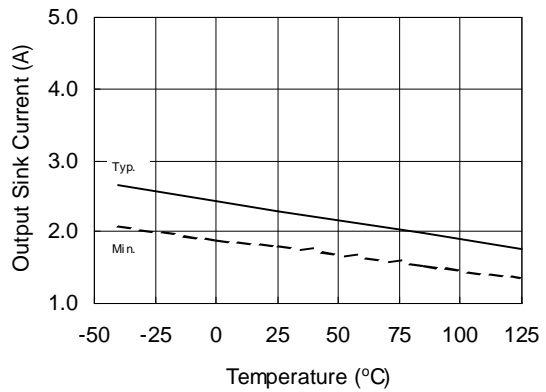


Figure 26A. Output Sink Current vs. Temperature

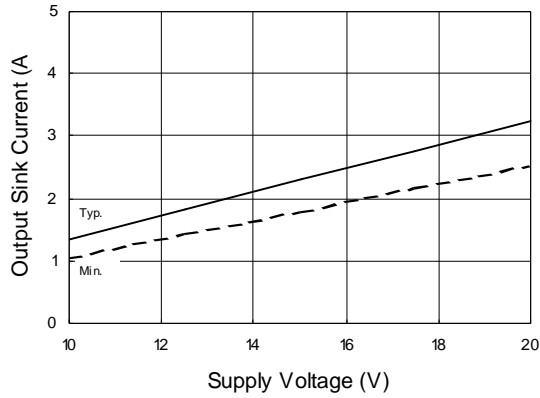
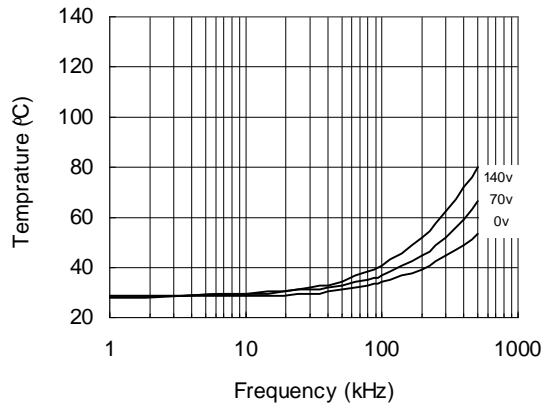
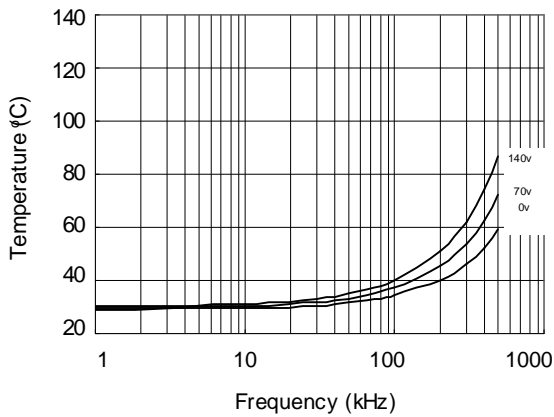


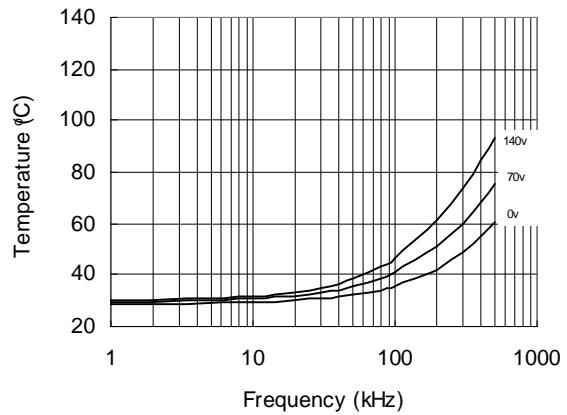
Figure 26B. Output Sink Current vs. Supply Voltage



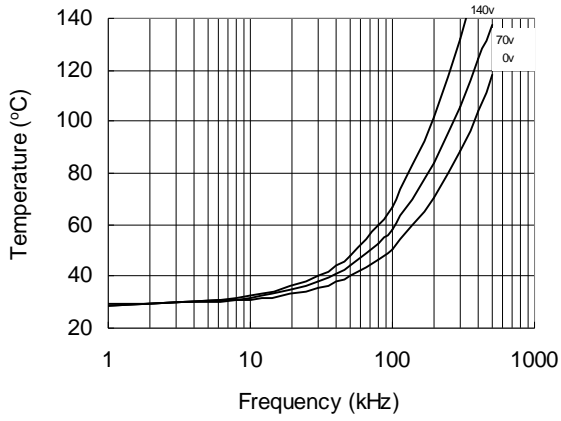
**Figure 27. IRS2181 vs. Frequency (IRFBC20),
 $R_{gate}=33\ \Omega$, $V_{CC}=15\ V$**



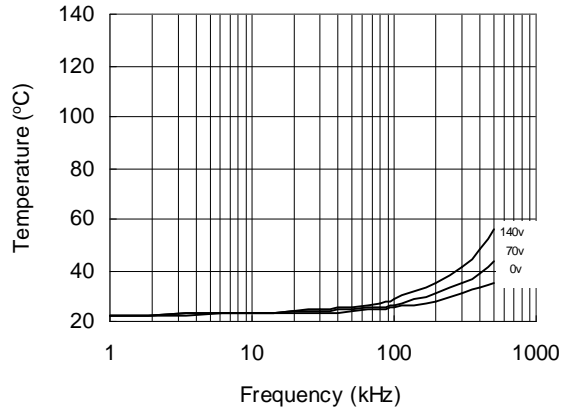
**Figure 28. IRS2181 vs. Frequency (IRFBC30),
 $R_{gate}=22\ \Omega$, $V_{CC}=15\ V$**



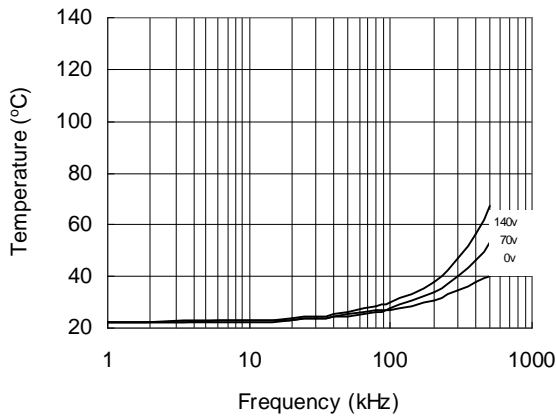
**Figure 29. IRS2181 vs. Frequency (IRFBC40),
 $R_{gate}=15\ \Omega$, $V_{CC}=15\ V$**



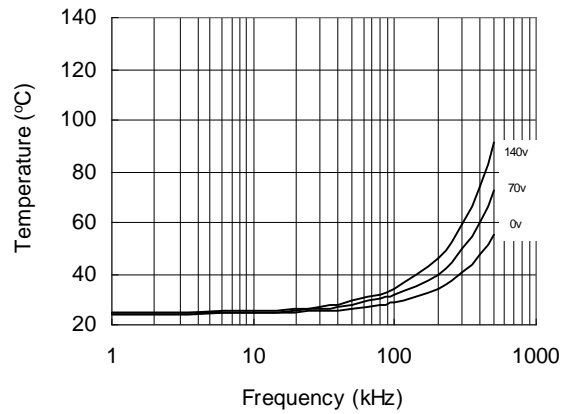
**Figure 30. IRS2181 vs. Frequency (IRFPE50),
 $R_{gate}=10\text{ W}$, $V_{cc}=15\text{ V}$**



**Figure 31. IRS21814 vs. Frequency (IRFBC20),
 $R_{gate}=33\text{ W}$, $V_{cc}=15\text{ V}$**

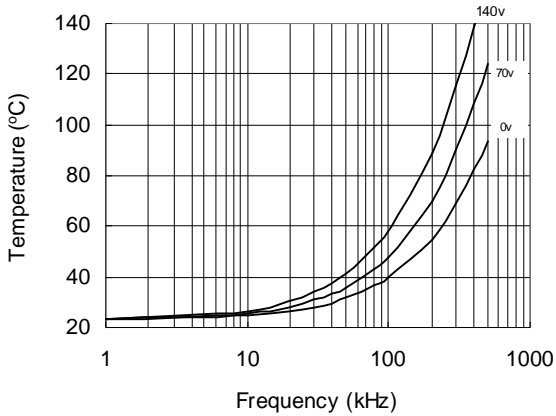


**Figure 32. IRS21814 vs. Frequency (IRFBC30),
 $R_{gate}=22\text{ W}$, $V_{cc}=15\text{ V}$**

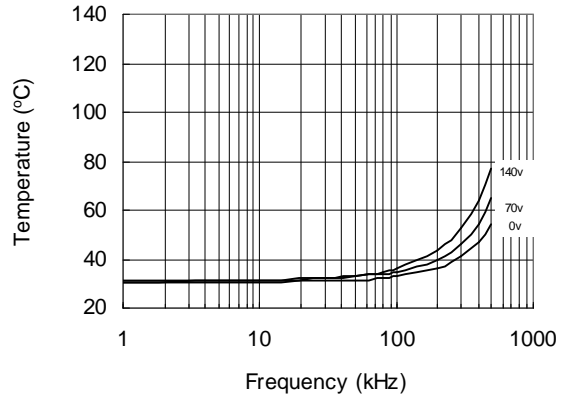


**Figure 33. IRS21814 vs. Frequency (IRFBC40),
 $R_{gate}=15\text{ W}$, $V_{cc}=15\text{ V}$**

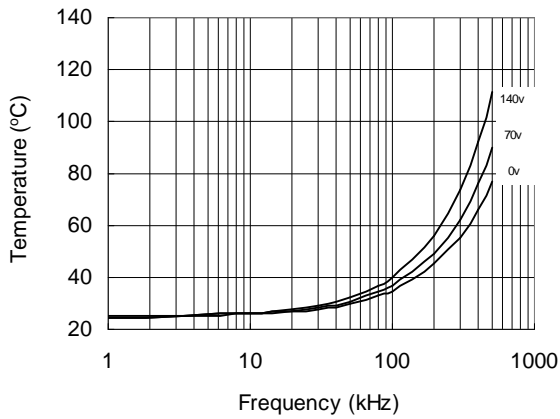
IRS2184/IRS21844(S)PbF



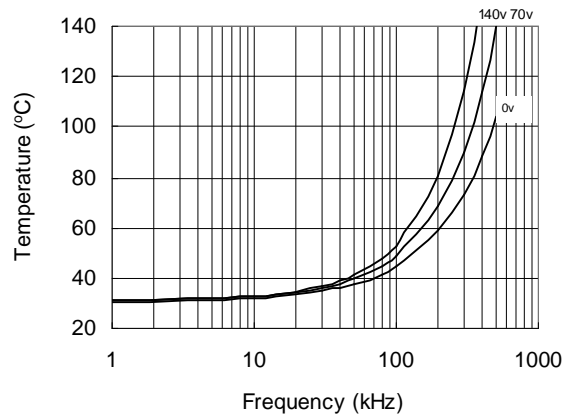
**Figure 34. IRS21814 vs. Frequency (IRFPE50),
 $R_{gate}=10\text{ W}, V_{CC}=15\text{ V}$**



**Figure 35. IRS2181s vs. Frequency (IRFBC20),
 $R_{gate}=33\text{ W}, V_{CC}=15\text{ V}$**

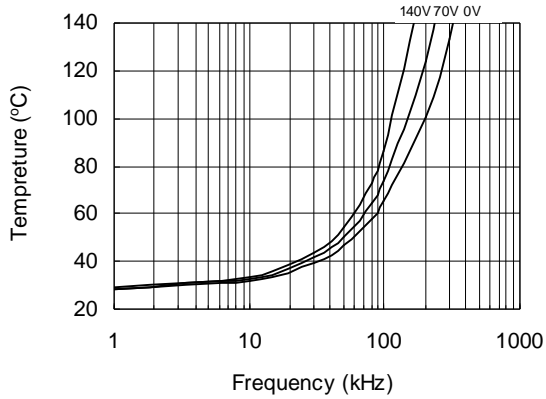


**Figure 36. IRS2181s vs. Frequency (IRFBC30),
 $R_{gate}=22\text{ W}, V_{CC}=15\text{ V}$**

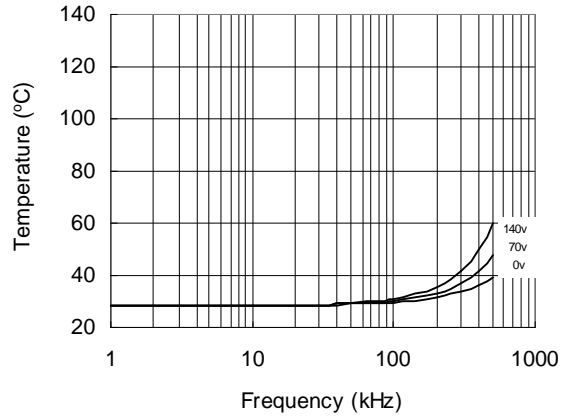


**Figure 37. IRS2181s vs. Frequency (IRFBC40),
 $R_{gate}=15\text{ W}, V_{CC}=15\text{ V}$**

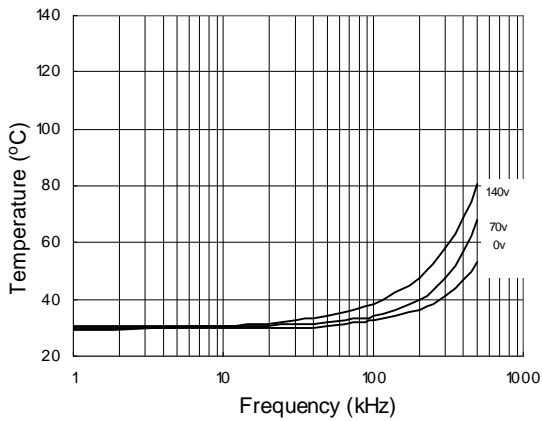
IRS2184/IRS21844(S)PbF



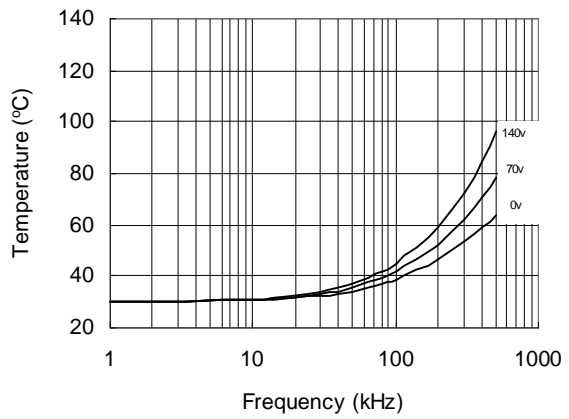
**Figure 38. IRS2181s vs. Frequency (IRFPE50),
 $R_{gate}=10\text{ W}, V_{CC}=15\text{ V}$**



**Figure 39. IRS21814s vs. Frequency (IRFBC20),
 $R_{gate}=33\text{ W}, V_{CC}=15\text{ V}$**



**Figure 40. IRS21814s vs. Frequency (IRFBC30),
 $R_{gate}=22\text{ W}, V_{CC}=15\text{ V}$**



**Figure 41. IRS21814s vs. Frequency (IRFBC40),
 $R_{gate}=15\text{ W}, V_{CC}=15\text{ V}$**

IRS2184/IRS21844(S)PbF

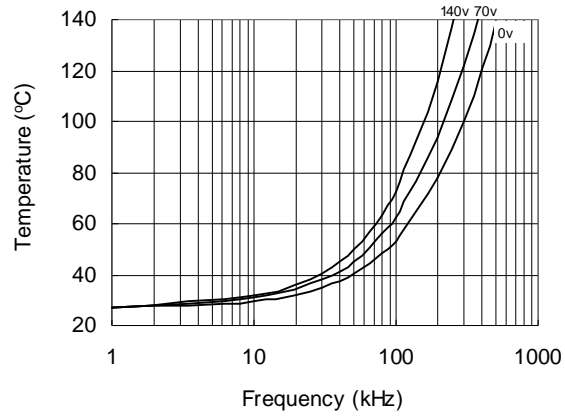
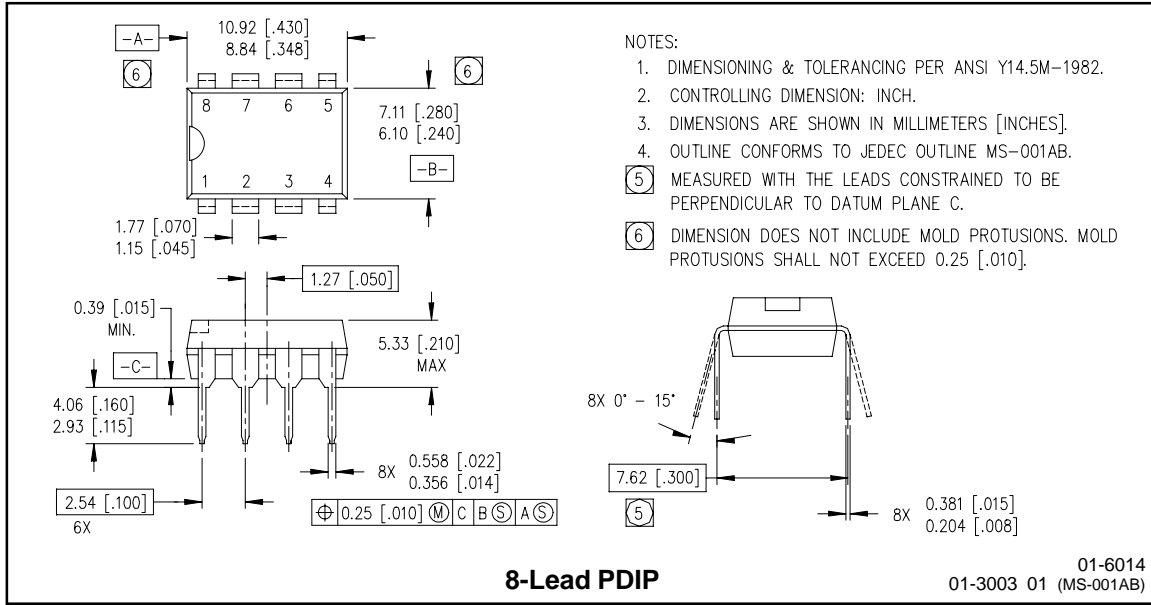
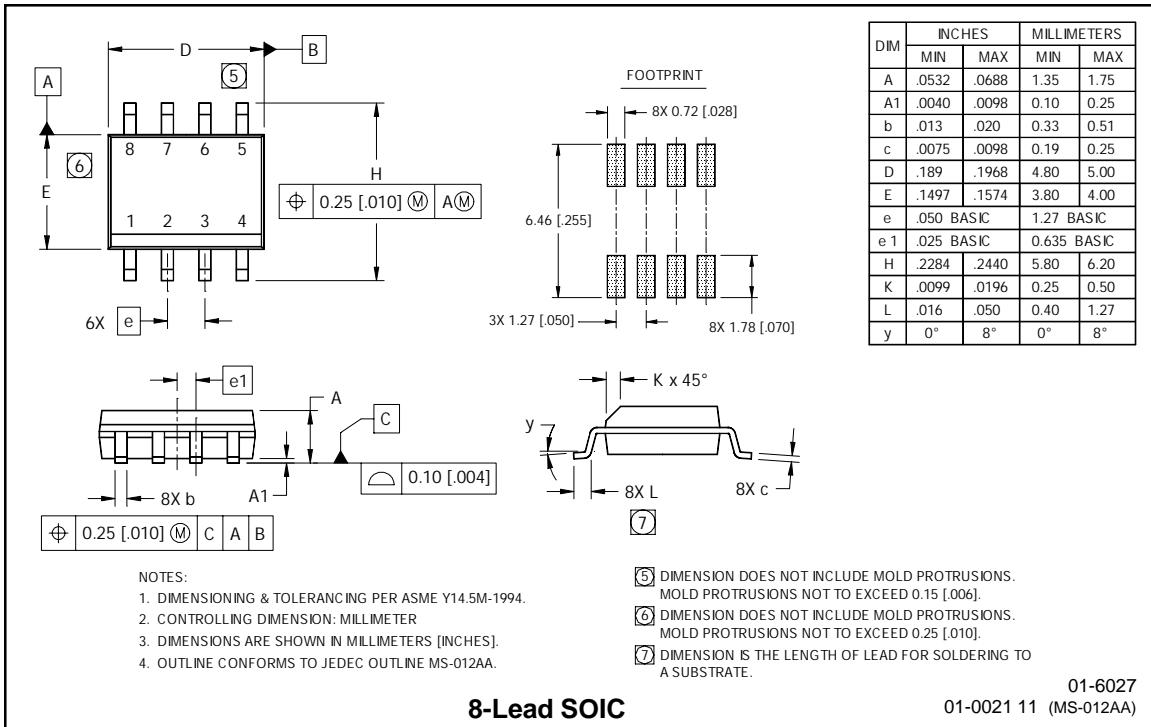


Figure 42. IRS2184s vs. Frequency (IRFPE50),
 $R_{gate}=10\text{ W}$, $V_{cc}=15\text{ V}$

Cast Outlines

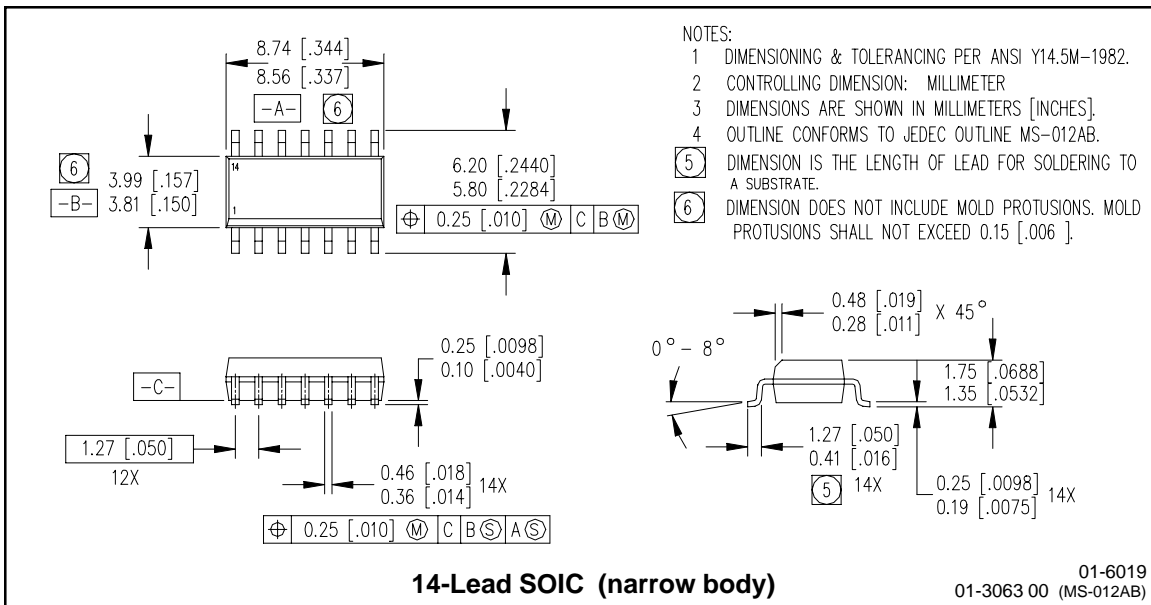
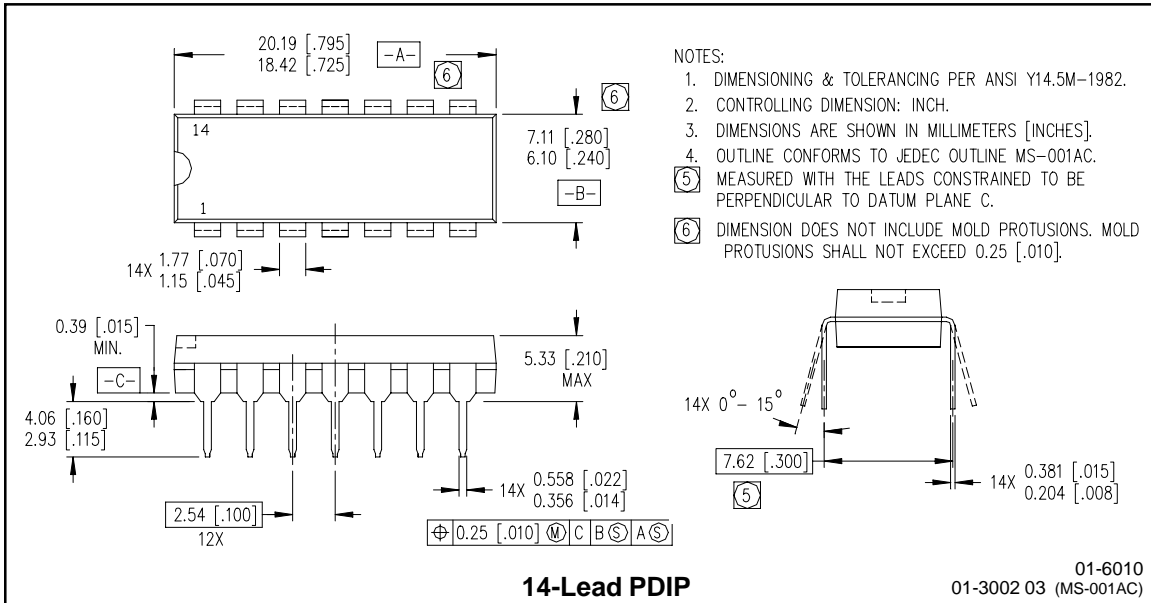


8-Lead PDIP

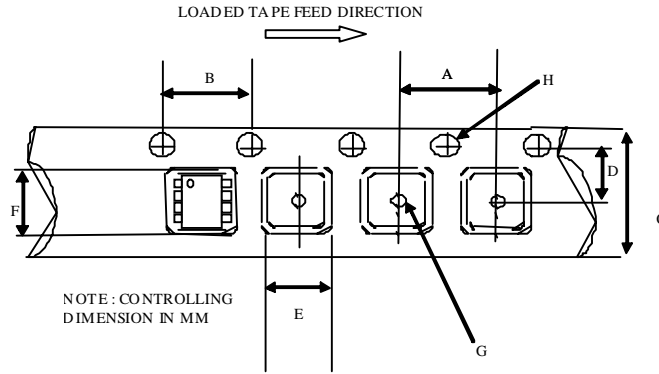


8-Lead SOIC

IRS2184/IRS21844(S)PbF

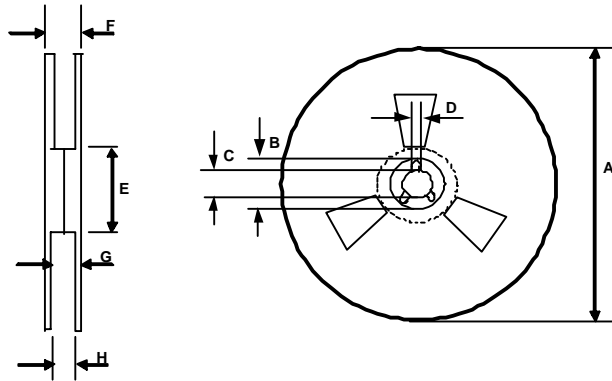


Tape & Reel 8-lead SOIC



CARRIER TAPE DIMENSION FOR 8SOICN

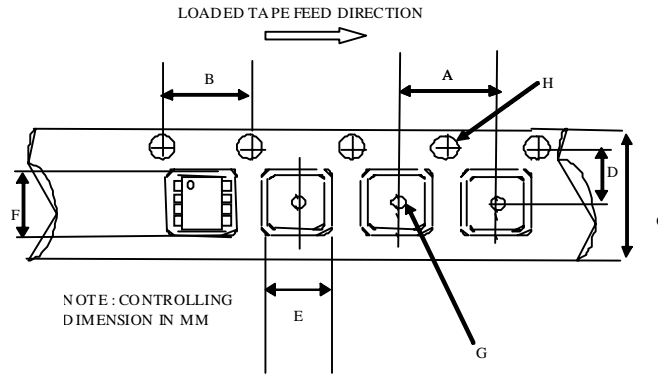
Code	Metric		Imperial	
	Min	Max	Min	Max
A	7.90	8.10	0.311	0.318
B	3.90	4.10	0.153	0.161
C	11.70	12.30	0.46	0.484
D	5.45	5.55	0.214	0.218
E	6.30	6.50	0.248	0.255
F	5.10	5.30	0.200	0.208
G	1.50	n/a	0.059	n/a
H	1.50	1.60	0.059	0.062



REEL DIMENSIONS FOR 8SOICN

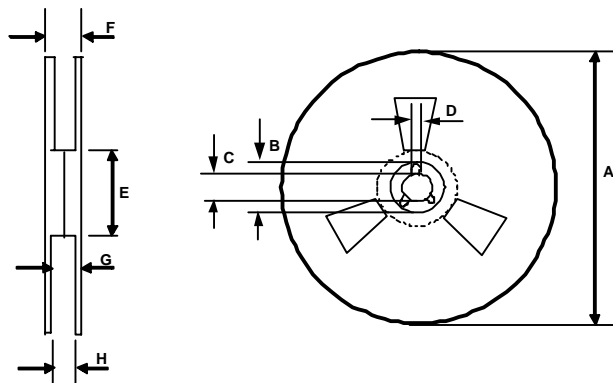
Code	Metric		Imperial	
	Min	Max	Min	Max
A	329.60	330.25	12.976	13.001
B	20.95	21.45	0.824	0.844
C	12.80	13.20	0.503	0.519
D	1.95	2.45	0.767	0.096
E	98.00	102.00	3.858	4.015
F	n/a	18.40	n/a	0.724
G	14.50	17.10	0.570	0.673
H	12.40	14.40	0.488	0.566

Tape & Reel 14-lead SOIC



CARRIER TAPE DIMENSION FOR 14SOICN

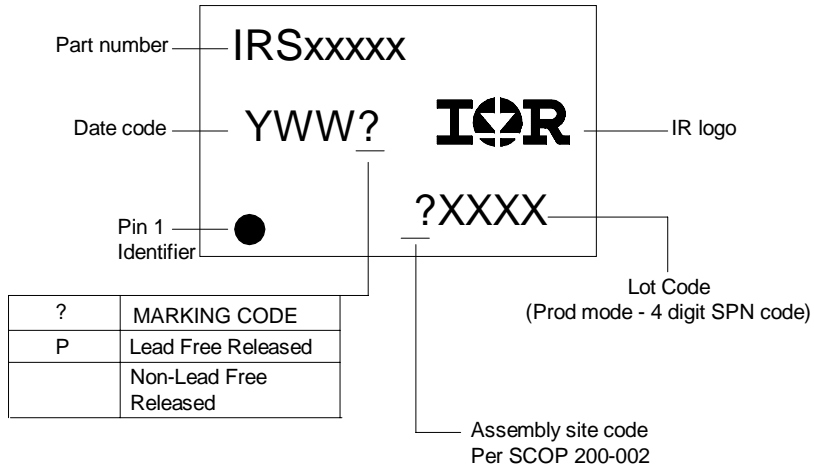
Code	Metric		Imperial	
	Min	Max	Min	Max
A	7.90	8.10	0.311	0.318
B	3.90	4.10	0.153	0.161
C	15.70	16.30	0.618	0.641
D	7.40	7.60	0.291	0.299
E	6.40	6.60	0.252	0.260
F	9.40	9.60	0.370	0.378
G	1.50	n/a	0.059	n/a
H	1.50	1.60	0.059	0.062



REEL DIMENSIONS FOR 14SOICN

Code	Metric		Imperial	
	Min	Max	Min	Max
A	329.60	330.25	12.976	13.001
B	20.95	21.45	0.824	0.844
C	12.80	13.20	0.503	0.519
D	1.95	2.45	0.767	0.096
E	98.00	102.00	3.858	4.015
F	n/a	22.40	n/a	0.881
G	18.50	21.10	0.728	0.830
H	16.40	18.40	0.645	0.724

LEADFREE PART MARKING INFORMATION



ORDER INFORMATION

8-Lead PDIP IRS2184PbF	14-Lead PDIP IR2S1844PbF
8-Lead SOIC IRS2184SPbF	14-Lead SOIC IRS21844SPbF
8-Lead SOIC Tape & Reel IRS2184STRPbF	14-Lead SOIC Tape & Reel IRS21844STRPbF